

Features

- DALI-2 certified
- DALI or PUSH dimmable, time-control dimming
- Output current and parameters set via NFC programmer
- Support external NTC resistor to monitor luminaire temperature
- Full protection: over voltage, under voltage, overload, over-temperature and short-circuit protection
- Surge protection: L-N: 6KV; L/N-GND: 10KV
- Complies with Zhaga Book 13
- IP20; suitable for Class I/II light fixtures (IP>54)



Applications

· Street lighting · tunnel lighting · indoor lighting

Descriptions

LF-ACD040A-1050-57 is a 40W (max.) DALI NFC dimmable constant current LED driver. Its rated input voltage ranges from 220 to 240Vac and its maximum loaded voltage is 115V. Its output current is adjustable from 200 to 1050mA. It supports DT6, PUSH and time-control dimming. Output current and time-control dimming can be set via NFC programmer.

Product Model

LF - ACD 040A -1050 - 57

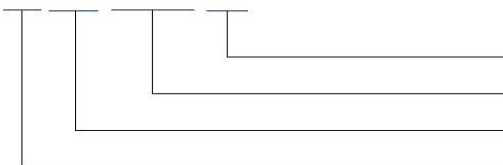

- 57: max. output voltage: 57Vdc
- 1050: max. output current: 1050mA
- 040: output power: 40W; A: DALI-2 series
- ACD: DALI dimmable LED driver

Lifud Technology Co., Ltd.

Production Base I (HQ): Building B, Kutto Industrial Park, NO.26 Xinhe Road, Bao'an District, Shenzhen, China.
 Production Base II: No.4, Block 2, Tengfei Road, Shigao Economic Development Zone, Tianfu New Area, Sichuan, China.
 Website: www.lifud.com Telephone: +86(0)755 8373 9299 Email: sales@lifud.com

■ Electrical Characteristics

Model		LF-ACD040A-1050-57				
Output	Output Voltage	11-57V				
	Output Current	200-1050mA (default: 700mA)				
	Flicker Index	IEC-Pst \leq 1, CIE SVM \leq 0.4, Complies with IEEE Std 1789-2015				
	Current Tolerance	\pm 5%				
	Temperature Drift	\pm 10%				
	Start-up time	<1.5s				
Input	Input Voltage	220-240Vac (voltage limit: 180-264Vac)				
	DC Input Voltage	220-240Vdc (voltage limit: 180-264Vac)				
	Input Frequency	0/50/60Hz				
	Input Current	0.3A max. @AC input 0.053-0.254A @DC input				
	PF	\geq 0.95				
	THD	\leq 10%				
	Efficiency	\geq 89%				
	Inrush Current	<30A&150uS				
	Loading Quantities of Circuit Breaker	Model	B10	C10	B16	C16
		Quantity (pcs)	22	22	35	35
	Leakage Current	<0.7mA				
	Standby Power Consumption	\leq 0.5W (DALI OFF)				
Protections	Open Circuit	<59V (Power off and restart of AC is required after 45S of open circuit)				
	Short Circuit	Hiccup mode (auto-recovery)				
	Input Over-voltage Protection	AC320V \pm 3% (When the input voltage is over 320V, the protection starts and lower down the voltage to 270V to restore the operation)				
	Input Under-voltage Protection	AC150 \pm 3% (When the input voltage is under 150V, the protection starts and voltage rises to 160V to restore the operation)				
	Over-temperature protection	Protection starts when an external resistance of 1.6K Ω is detected at the NTC terminal				
Environment Descriptions	Operating Temperature	-40 $^{\circ}$ C~+55 $^{\circ}$ C				
	Operating Humidity	20-90%RH (no condensation)				
	Storage Temperature/ Humidity	-40 $^{\circ}$ C~+80 $^{\circ}$ C (6 months in Class I environment); 10-90%RH (no condensation)				
	Atmospheric Pressure	86-106kPa				

■ Electrical Characteristics

Safety and EMC	Certifications	ENEC、CCC、RCM、SAA、CE、CB、UKCA、EL
	Withstanding Voltage	I/P-O/P: 3.75kV 5mA 60S; I/P-PE: 1.5KV 5mA 60S; O/P-PE: 0.5KV 5mA 60S, I/P-DIM:0.5kV 5mA 60S,O/P-DIM:0.5kV 5mA 60S
	Insulation Resistance	I/P-O/P: >100MΩ@500VDC;I/P-PE: >100MΩ@500VDC;O/P-PE: >100MΩ@500VDC; I/P-DIM: >100MΩ@500VDC,O/P-DIM: >100MΩ@500VDC
	Safety Standards	ENEC: EN61347-1:2015, EN 61347-2-13:2014/A1:2017, EN 62384: 2016/A1:2009 CCC:GB19510.1-2009, GB19510.14-2009 RCM:AS 61347.2-13:2018 SAA:AS61347.2-13:2018 CE-LVD: EN 61347-2-13:2014/A1:2017, EN 61347-1:2015, EN 62493:2015 CB:IEC 61347-1:2015, IEC61347-2-3:2014, IEC 61347-2-13:2014/AMD1:2016ERP:EU 2019/2020@2019.12.05 EL:IEC 61347-2-13:2014 Annex J
	EMI	CE-EMC/RCM:EN55015, EN61000-3-2, EN61000-3-3 UKCA-EMC:EN IEC 55015:2019/A11:2020, EN 61547:2009, EN IEC 61000-3-2:2019/A1:2021, EN 61000-3-3:2013/A2:2021 CCC:GB/T17743, GB17625.1, GB17625.2
	EMS	CE-EMC/RCM: EN61000-4-2,3,4,5 (L-N:6KV,L/N-PE:10KV),6,11 CCC:GB/T17626.2,3,4,5 (L-N:6KV,L/N-PE:10KV),6,11
Other Parameters	IP Rating	IP20
	RoHS	RoHS 2.0 (EU) 2015/863
	Warranty Condition	5 years (Tc≤82°C)
	Compatibility of DALI Dimming	Yuanhao Master, Simon Master, Philips Master DDBC120-DALI, OSRAM Master, Helvar Master 905 Router, Tridonic Master and HDL MC64-DALI431 Master
	DALI Standard	IEC62386-101、102、207、250、251、252、253
	Noise Level	≤29dB (The noise collector should be tested at 10cm from the driver in a quiet room)

■ **Electrical Characteristics**

<p>Testing Equipment</p>	<p>AC power source: CHROMA6530, digital power meter: CHROMA66202, oscilloscope: Tektronix DPO3014, DC electronic load: M9712B, LED board, constant temperature and humidity chamber; Everfine EMS61000-5B, fast transient generator: Everfine EMS61000-4A, spectroanalyzer: KH3935, hi-pot tester: EEC SE7440, flicker tester (flicker-free coefficient test): Everfine LFA-3000, etc.</p>
<p>Testing Remark</p>	<p>If there are no special remarks, the above parameters are tested at the ambient temperature of 25°C, humidity of 50%, full load and input voltage of 230Vac/50Hz.</p>
<p>Additional Remarks</p>	<p>1. It is recommended that user install the over voltage protection, under voltage protection and surge protection devices in the power supply circuits of light fixtures to ensure electricity safety.</p> <p>2. The LED driver used in combination with the end device is one of the accessories of the whole light fixture, and the EMC of the whole light fixture is not only susceptible to the driver itself, but to the LED light fixture and the whole light fixture's wiring. Thus, the manufacturer of LED light fixture should re-confirm the EMC of the whole light fixture before the whole light fixture is finished.</p> <p>3. The test conditions of the circuit breaker configuration quantity are the same as those of the inrush current.</p> <p>4. The total output power of the driver can not exceed the rated maximum power during use, otherwise it can not be guaranteed.</p> <p>Remark:</p> <p>①When the load voltage of the product is 17-38Vdc, it will output constant current with the maximum of 1050mA, and when the load voltage is over 38Vdc, it will output no more than 40W.</p> <p>②The default current of the product is 700mA. The output current can be set by our programmer (or FEIG NFC reader) with the master.</p>

■ **Protective Characteristics Schematic**

Schematic diagram of input undervoltage protection

Schematic diagram of input overvoltage protection

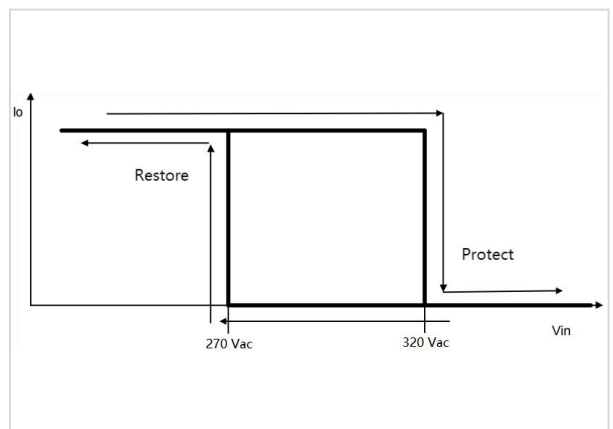
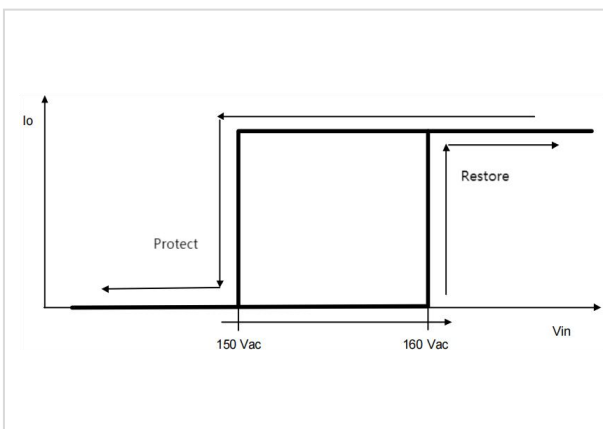

■ Product Characteristic Curves

PF Curve

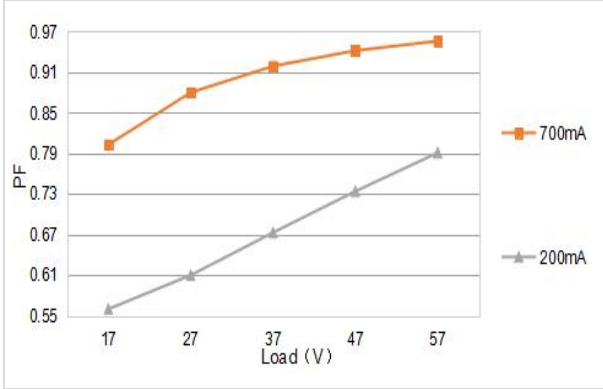

PF Curve

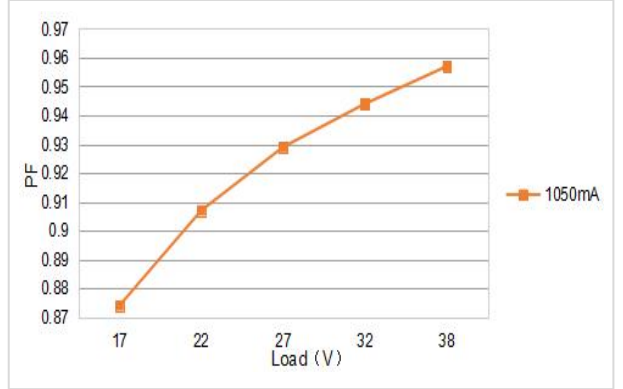

Efficiency Curve

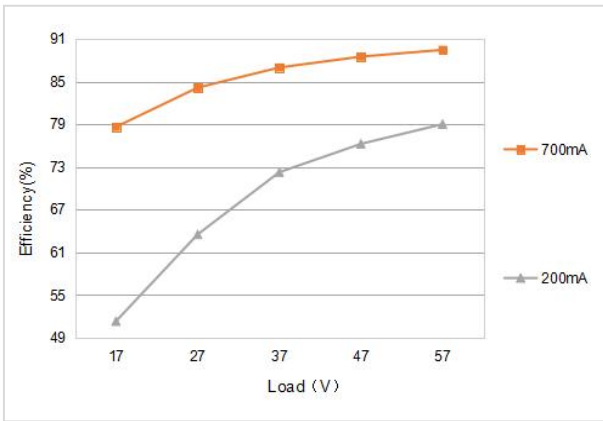

Efficiency Curve

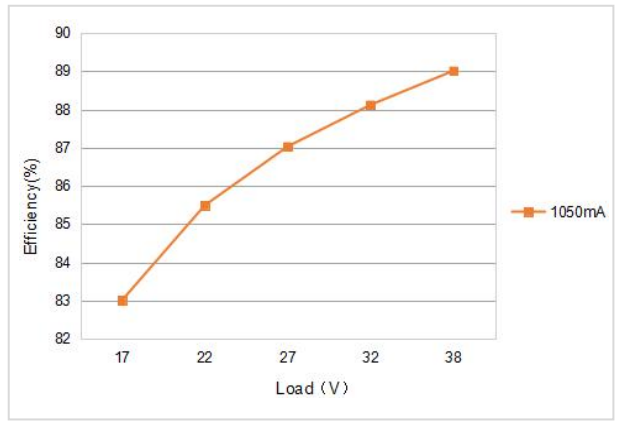

Working Curve

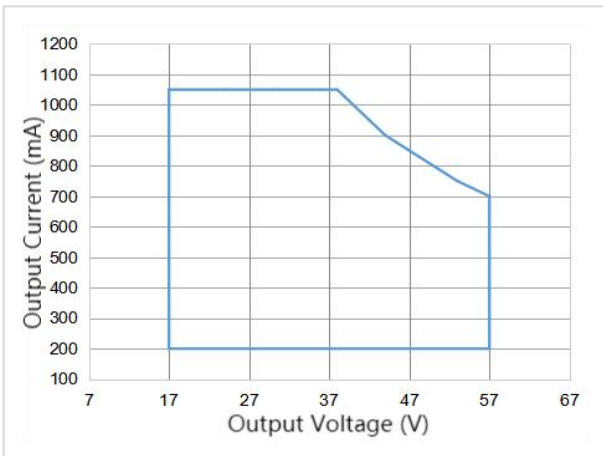

Lifetime Curve

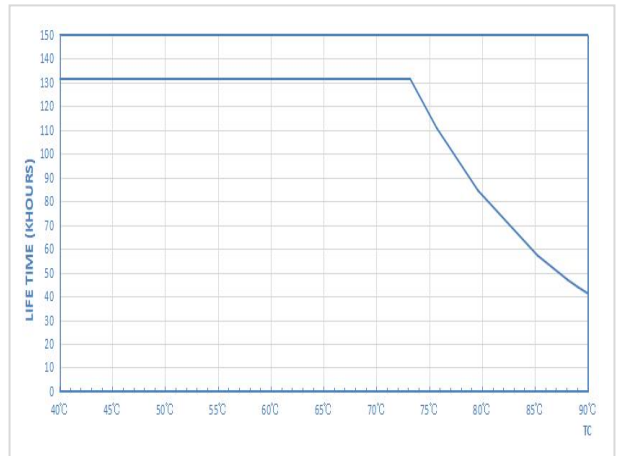

■ **Product Characteristic Curves**

Tc Point (unit: mm)

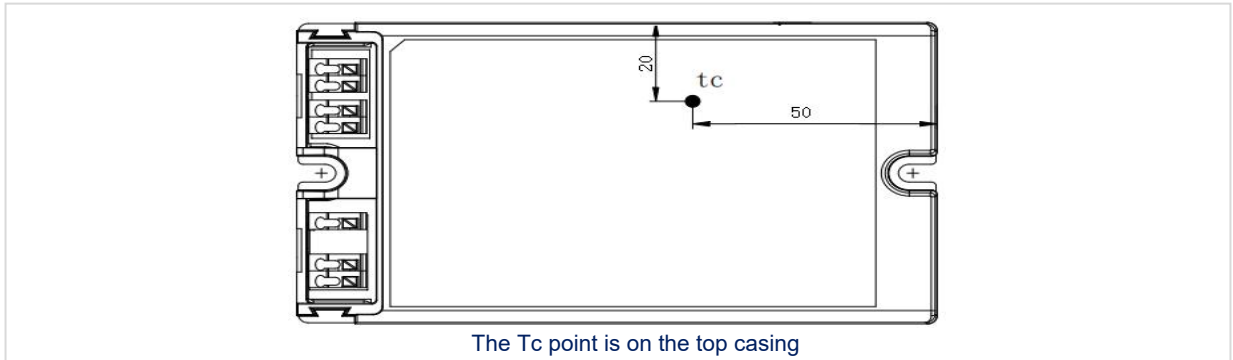

■ **Product Terminal Definition**

Product Terminals

INPUT		OUTPUT	
PE	Earth wire	LED-	Negative electrode of LED board in series
/	/	LED+	Positive electrode output of LED driver
AC-N	AC neutral wire input	NTC-	Negative electrode of NTC Temperature Sensor
AC-L	AC live wire input	NTC+	Positive electrode of NTC Temperature Sensor
/	/	DA2 PUSH	DALI 2/PUSH dimming input
/	/	DA1 PUSH	DALI 1/PUSH dimming input

■ **NFC Time-control Dimming Introduction**

- It's DALI logarithmic dimming mode for factory default setting. If you need time-control dimming mode, please use the NFC master to switch.
- Install the NFC master and the supporting driver first.
- Turn on the master software: NFC Reader
- After putting the driver on the reader and reading the data, it will display the model of the driver and the current value. Click on the time-control dimming, select "Enable", set the running time and fade time, and finally click on the "Write".
- There are 3 modes of time-control dimming including traditional timed dimming, adaptive midpoint alignment dimming and adaptive percentage dimming, which have the same operation interface.
 1. Traditional timed dimming: Select this function and the driver will work according to the set running time and brightness.
 2. Adaptive midpoint alignment dimming: Assuming that the midpoint of the dimming curve is the local midnight, the dimmer will automatically adjust the working curve according to the total working hours of each day in the past two days (the error is within 15 minutes).
 3. Adaptive percentage dimming: The dimmer automatically adjusts the working time proportionally to the working time of the last two days (within 15 minutes error) (proportionally increasing or decreasing according to the initialized time and the effective working time).
- The operation interface is shown as below:

■ **NFC Time-control Dimming Introduction**

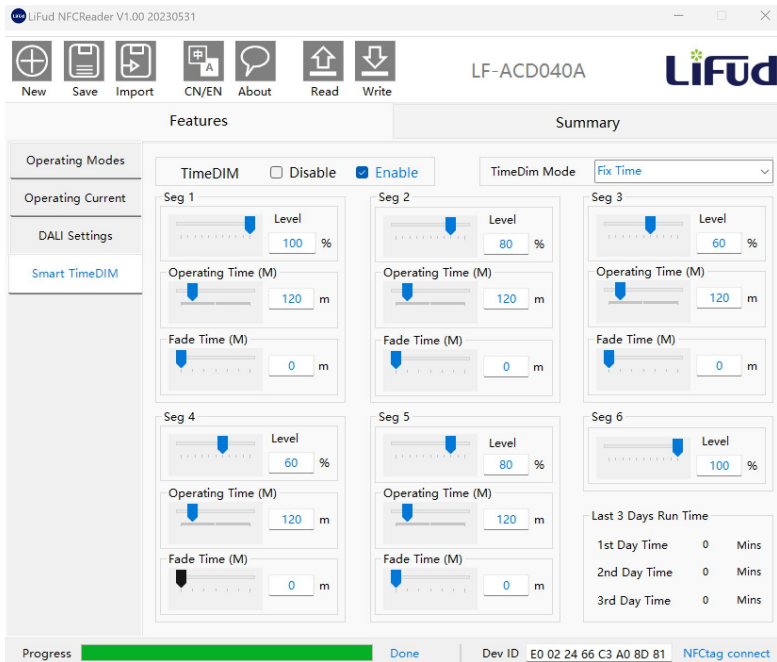

■ **NTC/DALI Control Wiring Diagram**

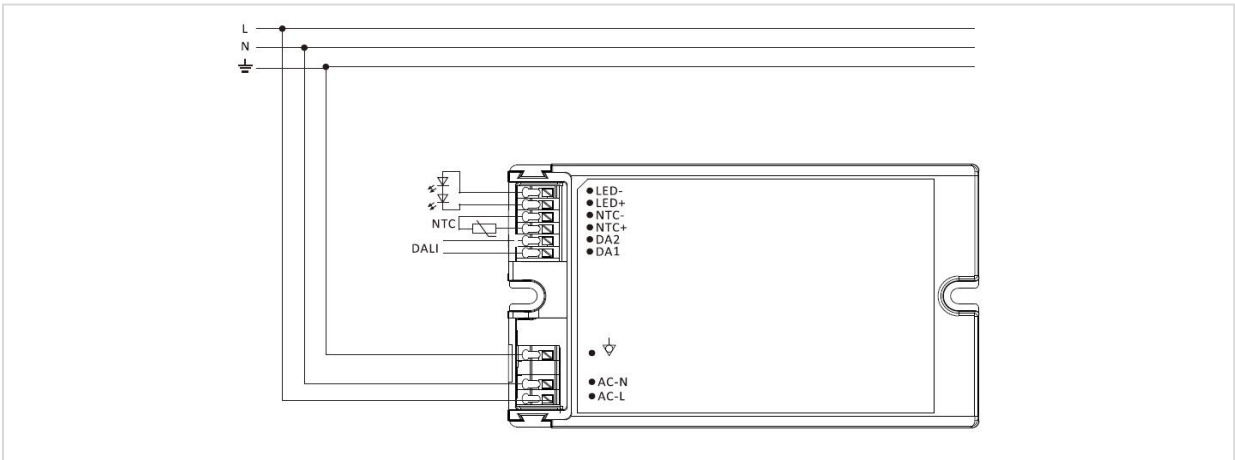

■ **NTC Control Introduction**

- Connect the NTC resistor to the NTC+ terminal and NTC- terminal. When the NTC resistor detects the high temperature of light fixtures, the resistance drops to about 1.6KΩ, the driver has no output, and then it needs to be re-powered in order to return to normal.
- Typical value of NTC resistance protection point at room temperature is 1.6KΩ.

■ **DALI Dimming Introduction**

- Default setting brightness is 100%.
- Connect DALI signal to DA1 and DA2 terminals.
- DALI protocol includes Max.16 scene groups.
- Maximum number of LED drivers connected in parallel in DALI dimming mode: 64 pcs.
- Dimming depth of DALI dimming: 1%. (Iout&Vout max)
- When DALI OFF, reset within 10s of power failure to keep OFF state.

■ **DALI Dimming Curve**

Linear dimming

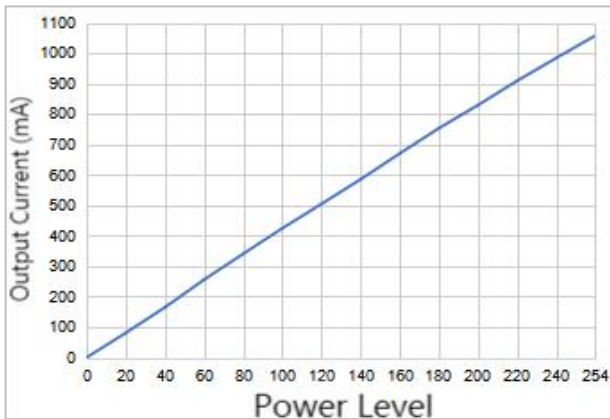

Logarithmic dimming

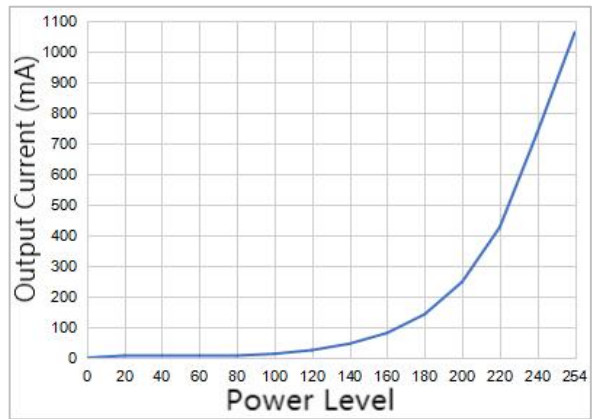

■ **Operations of PUSH Dimming**

Wiring Diagram of PUSH Dimming

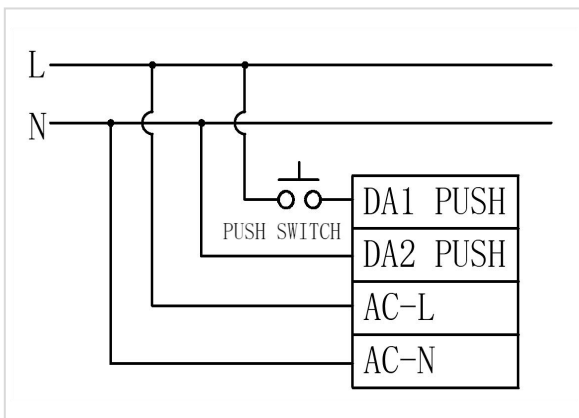

Remarks

- Connect PUSH switch between AC-L and DA1 PUSH in series and connect DA2 PUSH to AC-N.
- Make sure that AC-L and AC-N are NOT directly connected to DA1 PUSH and DA2 PUSH terminals.
- Make sure that PUSH switch is off before the AC is powered on; operate PUSH after the AC is powered on.
- Make sure the PUSH switch is off before disconnecting the AC.
- If you have any questions about the wiring and operation, please confirm with Lifud FAE.
- ⚠️ Wrong wiring or operation may cause damage to the driver.

■ Operations of PUSH Dimming

Operation	Duration	Function
Instant Push	0.1-0.5 sec	LED light on/off
Long Push	0.6-9 sec	LED light dim up/down
Reset Push	>9 sec	Reset the brightness of luminaire to 50%

- The PUSH operation won't cause any variations on LED driver if it's less than 0.1S.
- Minimum dimming depth of PUSH dimming: 1% (Iout&Vout max)
- The PUSH dimming mode has the memory function in case of any power failure. When the LED driver is powered on again, the light will return to the previous state before power failure.
- The present dimming direction of PUSH dimming is opposite to the former one.
- Max. wire length from the PUSH switch to the farthest LED driver: 135m; wire diameter: 12-24AWG
- Max. quantity of drivers connected in parallel in DALI dimming mode: 64 pcs.
- ⚠ Choose only ONE as opposed to use DALI or PUSH at the same time in case of the damage of DALI master.

■ Structure & Dimensions (unit: mm)

Model	Overall Appearance (L*W*H)	Distance Between 2 Positioning Holes (L)	Diameter of Positioning Hole (D)
LF-ACD040A-1050-57	132.6*76.5*33 mm	122.5 mm	4.5 mm

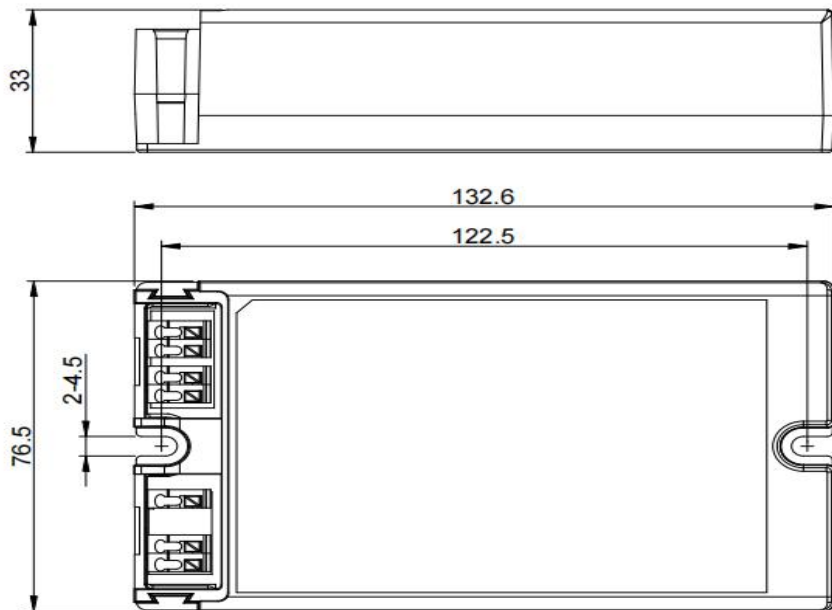

■ Packaging Specifications

Model	LF-ACD040A-1050-57
Carton Size	385*285*210mm (L*W*H)
Quantity	12 pcs/layer; 2 layers/ctn; 24 pcs/ctn
Weight	0.105 kg/pc; 3.0 kg/ctn

■ Transportation and Storage

1. Transportation

- Suitable transportation means: vehicles, boats and aeroplanes.
- In transit, it is necessary to prepare awnings for rain or sun protection. Moreover, please keep civilized loading and unloading to prevent the vibration or impact of LED driver as much as possible.

2. Storage

- The storage of LED driver shall conform to the standard of Class I environment. When using LED drivers which have been stored for more than 6 months, please re-test them firstly. Do not use them unless they are tested to be qualified.

Cautions

- Please use Lifud LED driver according to its parameters in the specification, otherwise the LED driver may malfunction.
- Using any incompatible light fixtures or those that have not been certified may cause fire, explosion or other risks.
- Man-made damage is beyond the scope of Lifud warranty service.

Remark: Lifud Technology Co., Ltd. reserves the right to interpret any contents of this specification.